

※ハン 使用材料 単位はmm

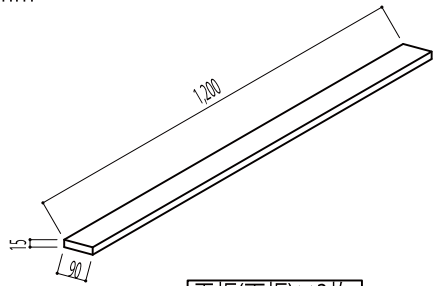

平板(天板)×3枚

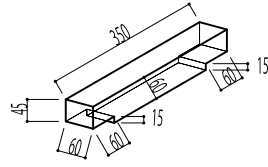

受け材×2本

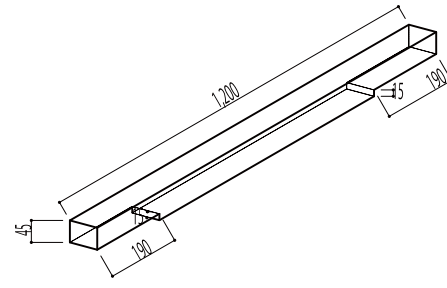

平板受け材×3本

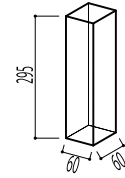

脚×4本

B側⇒

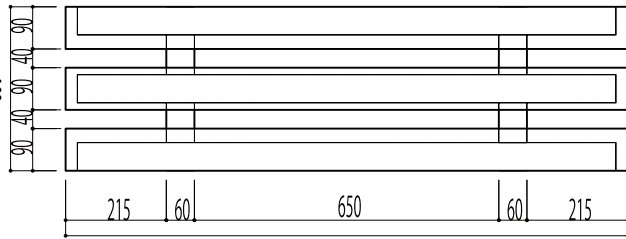

↑A側
平面図 1 / 10

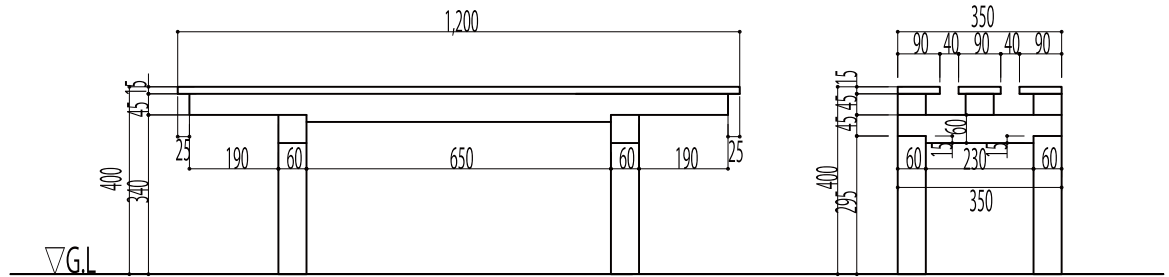

A側立面図 1 / 10

B側立面図 1 / 10

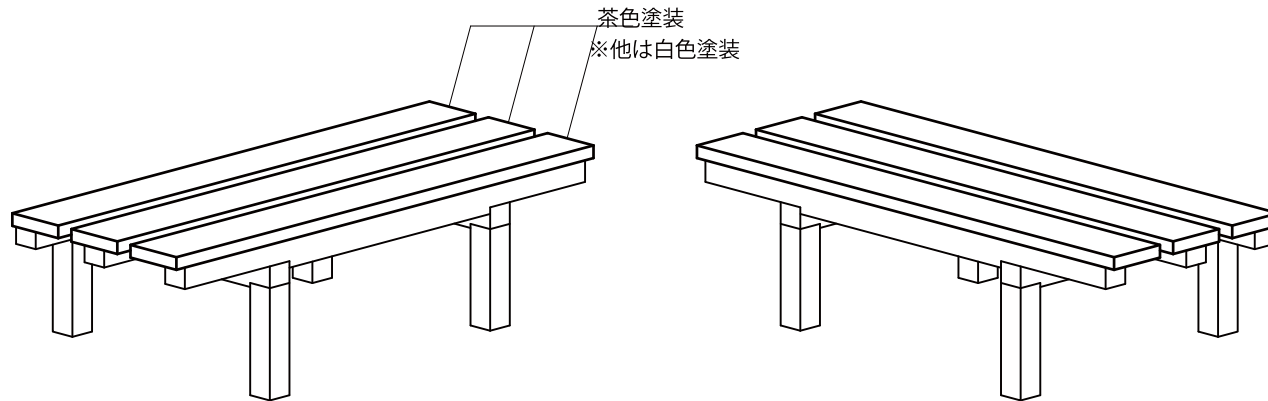

イメージパース